



ELECTROMAGNETIC COMPLIANCE TEST REPORT

For

X-ray machine

**Model: SHO-HX02, SHO-PXM01, SHO-SMP18, SHO-SP18, SHO-PX series,
SHO-PXU series, SHO-PXD series, SHO-PXF series, SHO-PXS series,
SHO-MDR Series, SHO-UDX series, SHO-DDX01, SHO-DDX02, SHO-DDX03,
SHO-DDX04, SHO-DDR01, SHO-DDR02, SHO-CMX01, SHO-DMS01,
SHO-DMS01, SHO-MAX series, SHO-V32-B, SHOCII-C3.5KW, SHOCII-3.5KW,
SHOCII-5KW, SHOC-5KW, SHOC-15KW, SHO-SFC5KW, SHOC-SFC15KW,
SHOC-CS01, SHO-DIP-001, SHO-IJP-001, RC-SLI6000, RC-SLI8000,
SHO-FPD02, SHO-FPD03, SHO-FPD04, SHO-FPD05, SHO-FPD06**

Brand Name: Shoimage

Report No.: ENC2506098GZ50E1

Date of Issue: Jun. 10, 2025

Prepared For

Suzhou Shoimage Medical Equipment Co., Ltd.

**Room 404, 4th Floor, Building A, Zhongke Innovation Plaza, No. 1555
Greenland Avenue, Huaqiao Town, Kunshan City, Suzhou City, Jiangsu
Province, China**

TEL: +86-0512-81635287

Prepared By

East Notice Certification Service Co., Ltd.

**1/F, Haohui Commercial Building, Zhuji Street, Dongpu Town, Tianhe District,
Guangzhou City, China**

The results shown in this test report refer only to the sample(s) tested unless otherwise stated and the sample(s) are retained for 30 days only. The document is issued by ENC, this document cannot be reproduced except in full with our prior written permission. The document is available on request and the brief information for its validation can be assessable and confirmed at <http://www.enc-lab.com>.



1/F, Haohui Commercial Building, Zhuji Street, Dongpu Town, Tianhe District, Guangzhou City
E-mail: enc@enc-lab.com Http:// www.enc-lab.com

TABLE OF CONTENTS

1. VERIFICATION OF CONFORMITY	3
2. TEST SUMMARY	4
3. SYSTEM DESCRIPTION	5
4. PRODUCT INFORMATION	6
5. SUPPORT EQUIPMENT	7
6. TEST FACILITY	8
7. EN 61000-6-3 LINE CONDUCTED EMISSION TEST	9
7.1. TEST EQUIPMENT OF CONDUCTED EMISSION TEST.....	9
7.2. LIMITS OF LINE CONDUCTED EMISSION TEST	9
7.3. BLOCK DIAGRAM OF TEST SETUP	9
7.4. PROCEDURE OF LINE CONDUCTED EMISSION TEST	10
7.5. TEST RESULT OF LINE CONDUCTED EMISSION TEST	11
8. EN 61000-6-3 RADIATED EMISSION TEST	13
8.1. TEST EQUIPMENT OF RADIATED R EMISSION TEST	13
8.2. LIMITS OF RADIATED EMISSION TEST	13
8.3. BLOCK DIAGRAM OF TEST SETUP	13
8.4. TEST RESULT OF RADIATED EMISSION TEST.....	14
9. IEC 61000-3-12 POWER HARMONICS TEST	16
9.1. TEST EQUIPMENT OF POWER HARMONICS TEST	16
9.2. BLOCK DIAGRAM OF TEST SETUP	16
9.3. LIMITS OF HARMONIC CURRENT	17
9.4. RESULT	18
10. IEC 61000-3-11 VOLTAGE FLUCTUATION / FLICKER TEST	19
10.1. TEST EQUIPMENT OF VOLTAGE FLUCTUATION / FLICKER TEST.....	19
10.2. BLOCK DIAGRAM OF TEST SETUP.....	19
10.3. RESULT	20
11. IEC 61000-4-2 ESD IMMUNITY TEST	21
11.1. TEST EQUIPMENT OF ESD TEST.....	21
11.2. BLOCK DIAGRAM OF TEST SETUP.....	21
10.3. TEST PROCEDURE	21
11.4. PERFORMANCE & RESULT	22
12. IEC 61000-4-3 TEST	23
12.1. TEST EQUIPMENT.....	23

The results shown in this test report refer only to the sample(s) tested unless otherwise stated and the sample(s) are retained for 30 days only. The document is issued by ENC, this document cannot be reproduced except in full with our prior written permission. The document is available on request and the brief information for its validation can be assessable and confirmed at <http://www.enc-lab.com>.



12.2. BLOCK DIAGRAM OF TEST SETUP.....	23
12.3. TEST PROCEDURE.....	24
12.4. PERFORMANCE & RESULT	24
13. IEC 61000-4-4 TEST.....	25
13.1. TEST EQUIPMENT.....	25
13.2. BLOCK DIAGRAM OF TEST SETUP.....	25
13.3. TEST PROCEDURE.....	26
13.4. PERFORMANCE & RESULT	26
14. IEC 61000-4-5 SURGE IMMUNITY TEST	27
14.1. TEST EQUIPMENT OF SURGE TEST	27
14.2. BLOCK DIAGRAM OF TEST SETUP.....	27
14.3. TEST PROCEDURE.....	28
14.4. PERFORMANCE & RESULT	28
15. IEC 61000-4-6 TEST.....	29
15.1. TEST EQUIPMENT.....	29
15.2. BLOCK DIAGRAM OF TEST SETUP.....	29
15.3. TEST PROCEDURE.....	30
15.4. PERFORMANCE & RESULT	30
16. IEC 61000-4-11 TEST.....	31
16.1. TEST EQUIPMENT.....	31
16.2. BLOCK DIAGRAM OF TEST SETUP.....	31
16.3. TEST PROCEDURE.....	32
16.4. PERFORMANCE.....	32
APPENDIX 1	33
PHOTOGRAPH(S) OF EUT.....	33

The results shown in this test report refer only to the sample(s) tested unless otherwise stated and the sample(s) are retained for 30 days only. The document is issued by ENC, this document cannot be reproduced except in full with our prior written permission. The document is available on request and the brief information for its validation can be assessable and confirmed at <http://www.enc-lab.com>.

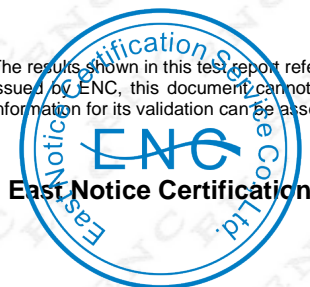

1. VERIFICATION OF CONFORMITY

Equipment Under Test:	X-ray machine
Model Number:	SHO-HX02, SHO-PXM01, SHO-SMP18, SHO-SP18, SHO-PX series, SHO-PXU series, SHO-PXD series, SHO-PXF series, SHO-PXS series, SHO-MDR Series, SHO-UDX series, SHO-DDX01, SHO-DDX02, SHO-DDX03, SHO-DDX04, SHO-DDR01, SHO-DDR02, SHO-CMX01, SHO-DMS01, SHO-DMS01, SHO-MAX series, SHO-V32-B, SHOCII-C3.5KW, SHOCII-3.5KW, SHOCII-5KW, SHOC-5KW, SHOC-15KW, SHO-SFC5KW, SHOC-SFC15KW, SHOC-CS01, SHO-DIP-001, SHO-IJP-001, RC-SLI6000, RC-SLI8000, SHO-FPD02, SHO-FPD03, SHO-FPD04, SHO-FPD05, SHO-FPD06
Model Difference:	The series models have same electrical structure as SHO-DDX04, only the different size of operation control panel.
Brand Name:	Shoimage
Applicant:	Suzhou Shoimage Medical Equipment Co., Ltd. Room 404, 4th Floor, Building A, Zhongke Innovation Plaza, No. 1555 Greenland Avenue, Huaqiao Town, Kunshan City, Suzhou City, Jiangsu Province, China
Manufacturer:	Suzhou Shoimage Medical Equipment Co., Ltd. Room 404, 4th Floor, Building A, Zhongke Innovation Plaza, No. 1555 Greenland Avenue, Huaqiao Town, Kunshan City, Suzhou City, Jiangsu Province, China
Type of Test:	EMC Directive 2014/30/EU for CE Marking
Technical Standards:	EN IEC 61000-6-3:2021 EN IEC 61000-6-1:2019
File Number:	ENC2506098GZ50E1
Date of test:	Jun. 2, 2025 – Jun. 10, 2025
Deviation:	None
Condition of Test Sample:	Normal

The above equipment was tested by East Notice Certification Service Co., Ltd. for compliance with the requirements set forth in EMC Directive 2014/30/EU and the Technical Standards mentioned above. This said equipment in the configuration described in this report shows the maximum emission levels emanating from equipment and the level of the immunity endurance of the equipment are within the compliance requirements. Should any objections to the test reports occurred, should submit it to the company within ten days since the issuing of the report, Fail to accept.

The test results of this report relate only to the tested sample identified in this report.

Checked By Yemig
Yemig Jun. 10, 2025

Authorized By Ray Zhou
Ray Zhou Jun. 10, 2025

The results shown in this test report refer only to the sample(s) tested unless otherwise stated and the sample(s) are retained for 30 days only. The document is issued by ENC, this document cannot be reproduced except in full with our prior written permission. The document is available on request and the brief information for its validation can be assessable and confirmed at <http://www.enc-lab.com>.

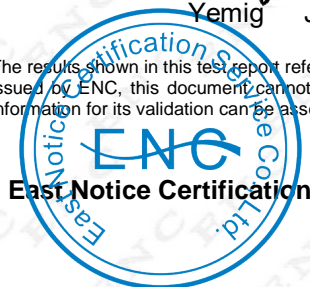

2. TEST SUMMARY

Standards	Results
EN IEC 61000-6-3:2021	PASS
CISPR 14-1	PASS
IEC 61000-3-2:2020 or IEC 61000-3-12:2011+A1:2021	PASS
IEC 61000-3-3:2017 or IEC 61000-3-11:2017	PASS
EN IEC 61000-6-1:2019	PASS
CISPR 14-2	PASS
IEC 61000-4-2:2008	PASS
IEC 61000-4-3:2020	PASS
IEC 61000-4-4:2012	PASS
IEC 61000-4-5:2017	PASS
IEC 61000-4-6:2013	PASS
IEC 61000-4-11:2020	PASS

N/A: Indicates that the test is not applicable

The results shown in this test report refer only to the sample(s) tested unless otherwise stated and the sample(s) are retained for 30 days only. The document is issued by ENC, this document cannot be reproduced except in full with our prior written permission. The document is available on request and the brief information for its validation can be assessable and confirmed at <http://www.enc-lab.com>.

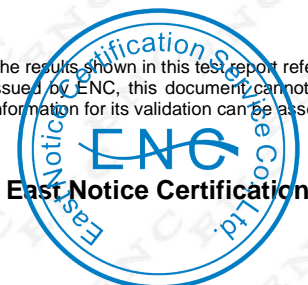

3. SYSTEM DESCRIPTION

EUT Test Procedure:

1. Connect EUT and peripheral devices if need.
2. Power on the EUT, the EUT begins to work.
3. Make sure the EUT operates normally during the test.

The results shown in this test report refer only to the sample(s) tested unless otherwise stated and the sample(s) are retained for 30 days only. The document is issued by ENC, this document cannot be reproduced except in full with our prior written permission. The document is available on request and the brief information for its validation can be assessable and confirmed at <http://www.enc-lab.com>.

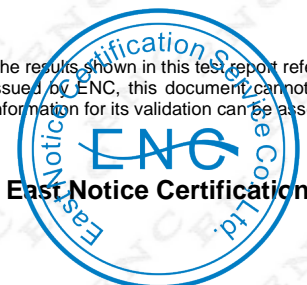

4. PRODUCT INFORMATION

Housing Type : Metal
Rated Voltage : 3N~380V~, 50Hz
Rated Power : 40KW
Protection Class : Class I

I/O Port Information (Applicable Not Applicable)

I/O Port of EUT			
I/O Port Type	Q'TY	Cable	Tested with
AC input port	1	2m	1

The results shown in this test report refer only to the sample(s) tested unless otherwise stated and the sample(s) are retained for 30 days only. The document is issued by ENC, this document cannot be reproduced except in full with our prior written permission. The document is available on request and the brief information for its validation can be assessable and confirmed at <http://www.enc-lab.com>.

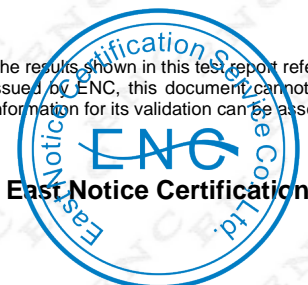

5. SUPPORT EQUIPMENT

Device Type	Manufacturer	Model Name	Serial No.	Data Cable	Power Cable
--	--	--	--	--	--

****Note:** All the above equipment/cables were placed in worse case positions to maximize emission signals during emission test.

Grounding: Grounding was in accordance with the manufacturer's requirements and conditions for the intended use.

The results shown in this test report refer only to the sample(s) tested unless otherwise stated and the sample(s) are retained for 30 days only. The document is issued by ENC, this document cannot be reproduced except in full with our prior written permission. The document is available on request and the brief information for its validation can be assessable and confirmed at <http://www.enc-lab.com>.

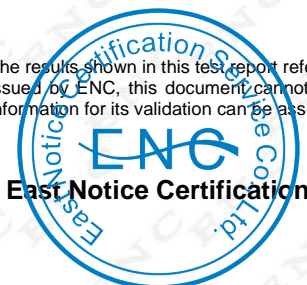

6. TEST FACILITY

Location: 1/F, Haohui Commercial Building, Zhuji Street, Dongpu Town, Tianhe District, Guangzhou City, China

Description: There is one 3m semi-anechoic an area test sites and two line conducted labs for final test. The Open Area Test Sites and the Line Conducted labs are constructed and calibrated to meet the FCC requirements in documents ANSI C63.4 and CISPR 14/EN 55014 requirements.

Site Filing: The site description is on file with the Federal Communications Commission, 7435 Oakland Mills Road, Columbia, MD 21046.

Instrument Tolerance: All measuring equipment is in accord with ANSI C63.4 and CISPR 14 requirements that meet industry regulatory agency and accreditation agency requirement.

The results shown in this test report refer only to the sample(s) tested unless otherwise stated and the sample(s) are retained for 30 days only. The document is issued by ENC, this document cannot be reproduced except in full with our prior written permission. The document is available on request and the brief information for its validation can be assessable and confirmed at <http://www.enc-lab.com>.

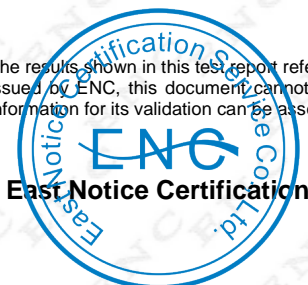

7. EN 61000-6-3 LINE CONDUCTED EMISSION TEST

7.1. TEST EQUIPMENT OF CONDUCTED EMISSION TEST

Description	Manufacturer	Model	Identifier	Last Cal.	Cal. Due
EMI Test Receiver	ROHDE & SCHWARZ	ESCI	1166.5950.03	15/01/2025	14/01/2026
LISN	ROHDE & SCHWARZ	ESH2-Z5	860014/010	15/01/2025	14/01/2026
Limitator	ROHDE & SCHWARZ	ESH3-Z2	1004008	15/01/2025	14/01/2026
The Impedance Stability Network ISN	FISCHER CUSTOM COMMUNICATIONS, INC.	F-071115-1057-1-09	112299	15/01/2025	14/01/2026
Software	ROHDE & SCHWARZ	ES-K1 V1.71	/	N/A	N/A

7.2. LIMITS OF LINE CONDUCTED EMISSION TEST

Frequency	Maximum RF Line Voltage	
	Q.P.(dBuV)	Average(dBuV)
150kHz-500kHz	66-56	56-46
500kHz-5MHz	56	46
5MHz-30MHz	60	50

****Note:** 1. The lower limit shall apply at the transition frequency.

2. The limit decreases linearly with the logarithm of the frequency in the range 0.15 MHz to 0.50 MHz

7.3. BLOCK DIAGRAM OF TEST SETUP

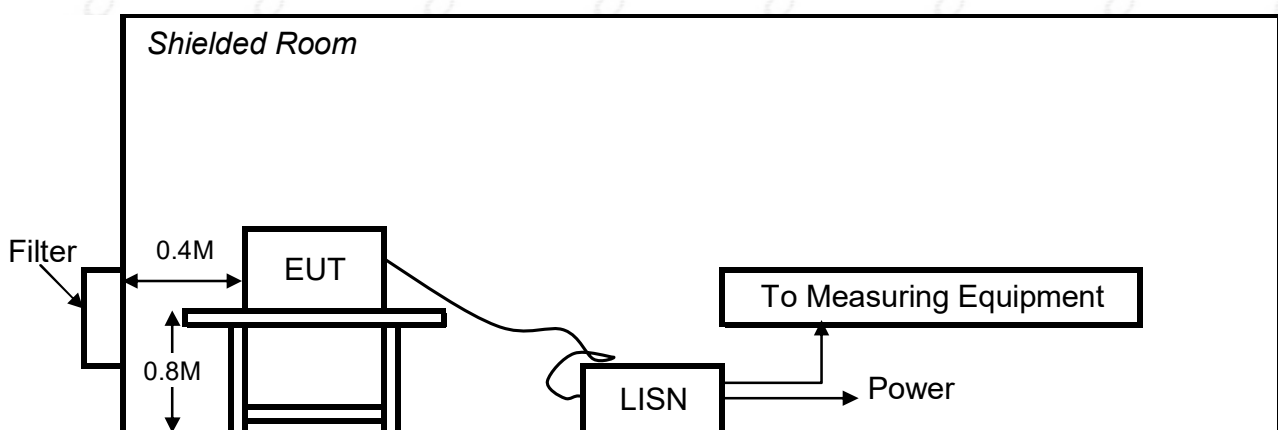

A: Powered through filter

The results shown in this test report refer only to the sample(s) tested unless otherwise stated and the sample(s) are retained for 30 days only. The document is issued by ENC, this document cannot be reproduced except in full with our prior written permission. The document is available on request and the brief information for its validation can be assessable and confirmed at <http://www.enc-lab.com>.

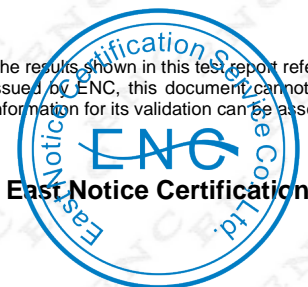

7.4. PROCEDURE OF LINE CONDUCTED EMISSION TEST

- 1) The equipment was set up as per the test configuration to simulate typical actual usage per the user's manual. When the EUT is a tabletop system, a wooden table with a height of 0.8 meters is used and is placed on the ground plane as per EN 61000-6-3 (see Test Facility for the dimensions of the ground plane used). When the EUT is a floor-standing equipment, it is placed on the ground plane which has a 3-12 mm non-conductive covering to insulate the EUT from the ground plane.
- 2) Support equipment, if needed, was placed as per EN 61000-6-3
- 3) All I/O cables were positioned to simulate typical actual usage as per EN 61000-6-3
- 4) The EUT received AC380V/50Hz power through a Line Impedance Stabilization Network (LISN) which supplied power source and was grounded to the ground plane.
- 5) All support equipments received power from a second LISN supplying power of AC 380V/50Hz, if any.
- 6) The EUT test program was started. Emissions were measured on each current carrying line of the EUT using a spectrum Analyzer / Receiver connected to the LISN powering the EUT. The LISN has two monitoring points: Line 1 (Hot Side) and Line 2 (Neutral Side). Two scans were taken: one with Line 1 connected to Analyzer / Receiver and Line 2 connected to a 50 ohm load; the second scan had Line 1 connected to a 50 ohm load and Line 2 connected to the Analyzer / Receiver.
- 7) Analyzer / Receiver scanned from 150 kHz to 30 MHz for emissions in each of the test modes.
- 8) During the above scans, the emissions were maximized by cable manipulation.
- 9) A scan was taken on both power lines, Line 1 and Line 2, recording at least the six highest emissions.
- 10) Emission frequency and amplitude were recorded into a computer in which correction factors were used to calculate the emission level and compare reading to the applicable limit. If EUT emission level was less -2dB to the A.V. limit in Peak mode, then the emission signal was re-checked using Q.P and Average detector.

The test data of the worst case condition(s) was reported on the Summary Data page.

The results shown in this test report refer only to the sample(s) tested unless otherwise stated and the sample(s) are retained for 30 days only. The document is issued by ENC, this document cannot be reproduced except in full with our prior written permission. The document is available on request and the brief information for its validation can be assessable and confirmed at <http://www.enc-lab.com>.

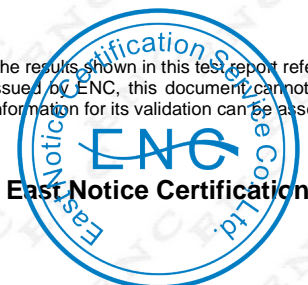

7.5. TEST RESULT OF LINE CONDUCTED EMISSION TEST

EUT : X-ray machine
M/N : SHO-DDX04
Mode : Normal, L

Power : AC380V
Temperature : 25°C
Humidity : 48%

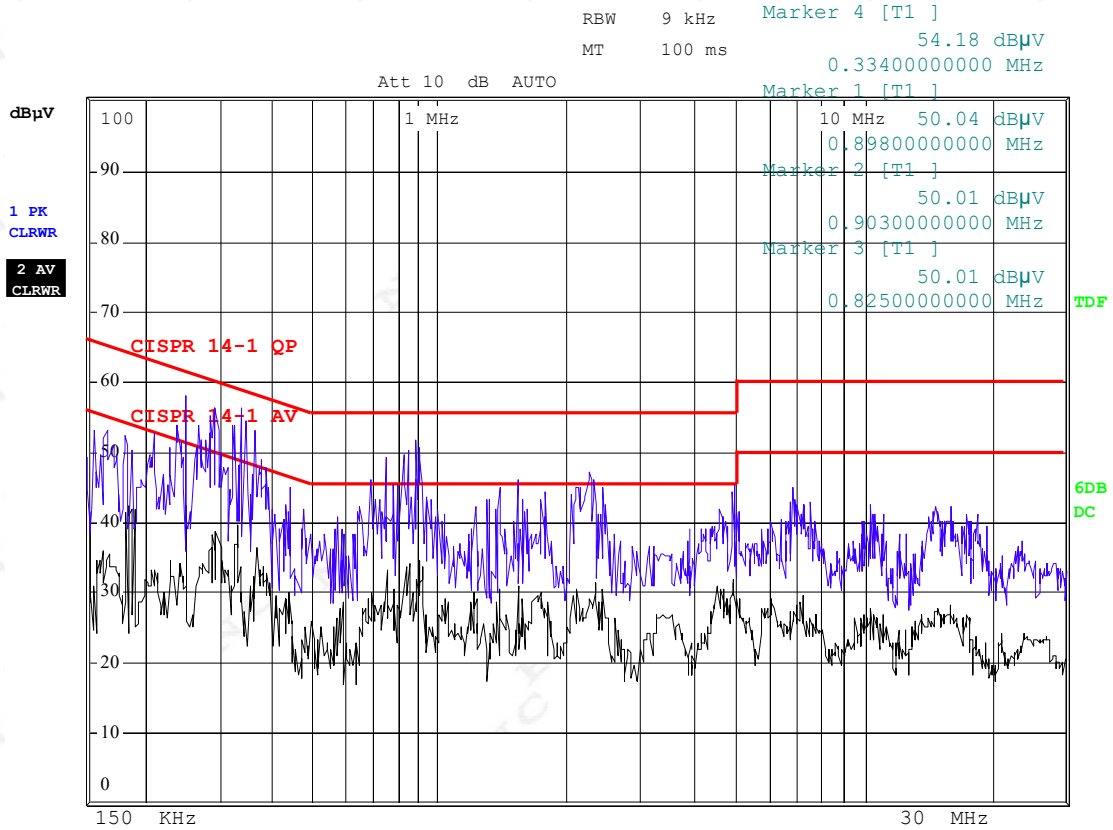

RESULT: PASS

The results shown in this test report refer only to the sample(s) tested unless otherwise stated and the sample(s) are retained for 30 days only. The document is issued by ENC, this document cannot be reproduced except in full with our prior written permission. The document is available on request and the brief information for its validation can be assessable and confirmed at <http://www.enc-lab.com>.





EUT : X-ray machine
M/N : SHO-DDX04
Mode : Normal, N

Power : AC380V
Temperature : 25°C
Humidity : 48%

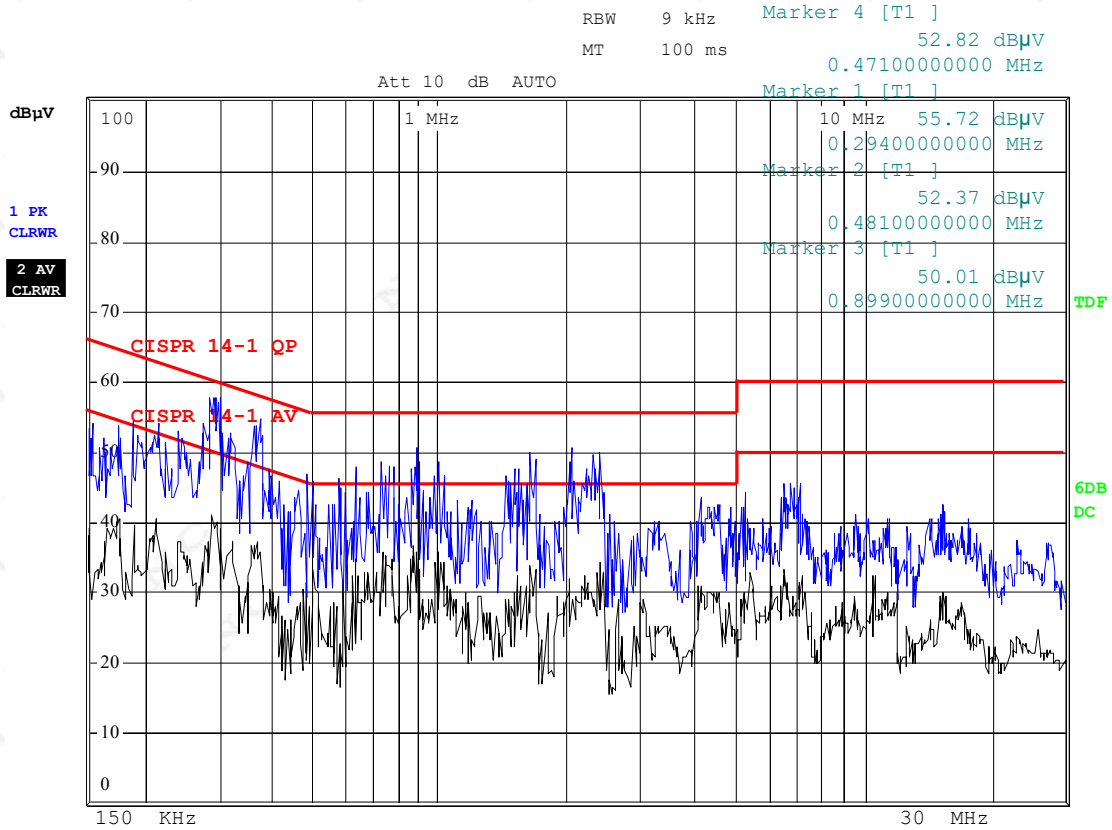

RESULT: PASS

The results shown in this test report refer only to the sample(s) tested unless otherwise stated and the sample(s) are retained for 30 days only. The document is issued by ENC, this document cannot be reproduced except in full with our prior written permission. The document is available on request and the brief information for its validation can be assessable and confirmed at <http://www.enc-lab.com>.



8. EN 61000-6-3 RADIATED EMISSION TEST

8.1. TEST EQUIPMENT OF RADIATED R EMISSION TEST

Description	Manufacturer	Model	Identifier	Last Cal.	Cal. Due
Test Receiver	R&S	CISPR 14	N/A	15/01/2025	14/01/2026
LISN	CSI	CLA-050	N/A	15/01/2025	14/01/2026
Limitator	TS	TS®90	N/A	15/01/2025	14/01/2026
Software	R&S	ES-K1 V1.71	/	N/A	N/A

8.2. LIMITS OF RADIATED EMISSION TEST

Frequency (MHz)	Distance(Meters)	Field Strengths Limits (dBµV/m)
30 ~ 230	3	40
230 ~ 1000	3	47

Note: (1) The tighter limit shall apply at the edge between two frequency bands.

(2) Distance refers to the distance in meters between the measuring instrument antenna and the closed point of any part of the EUT.

8.3. BLOCK DIAGRAM OF TEST SETUP

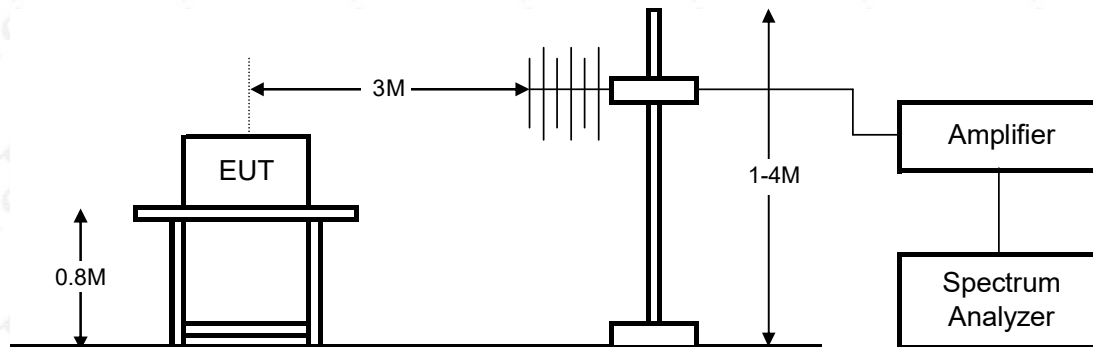

Test Procedure: The EUT was placed on a turn table which was 0.8 meter above ground. The turn table can rotate 360 degrees to determine the position of the maximum emission level.

EUT was set 3 meters away from the receiving antenna which was mounted on a antenna tower. The antenna can move up and down between 1 to 4 meters to find out the maximum emission level. Broadband antenna (calibrated biconical and log periodical antenna) were used as a receiving antenna. Both horizontal and vertical polarization of the antenna were set on measurement.

The bandwidth of the R&S Test Receiver ESVP was set at 120kHz.

The frequency range from 30MHz to 1000MHz was checked.

According to the requirement of EN 61000-6-3 (CISPR 14) clause 10.4, all cables leaving the Table-Top EUT for a connection outside the test side were fitted with ferrite clamps(specified by CISPR 14-1) placed on the turn-table at the point where the cable reaches the turn-table.

The results shown in this test report refer only to the sample(s) tested unless otherwise stated and the sample(s) are retained for 30 days only. The document is issued by ENC, this document cannot be reproduced except in full with our prior written permission. The document is available on request and the brief information for its validation can be assessable and confirmed at <http://www.enc-lab.com>.

8.4. TEST RESULT OF RADIATED EMISSION TEST

Radiated Emission Measurement

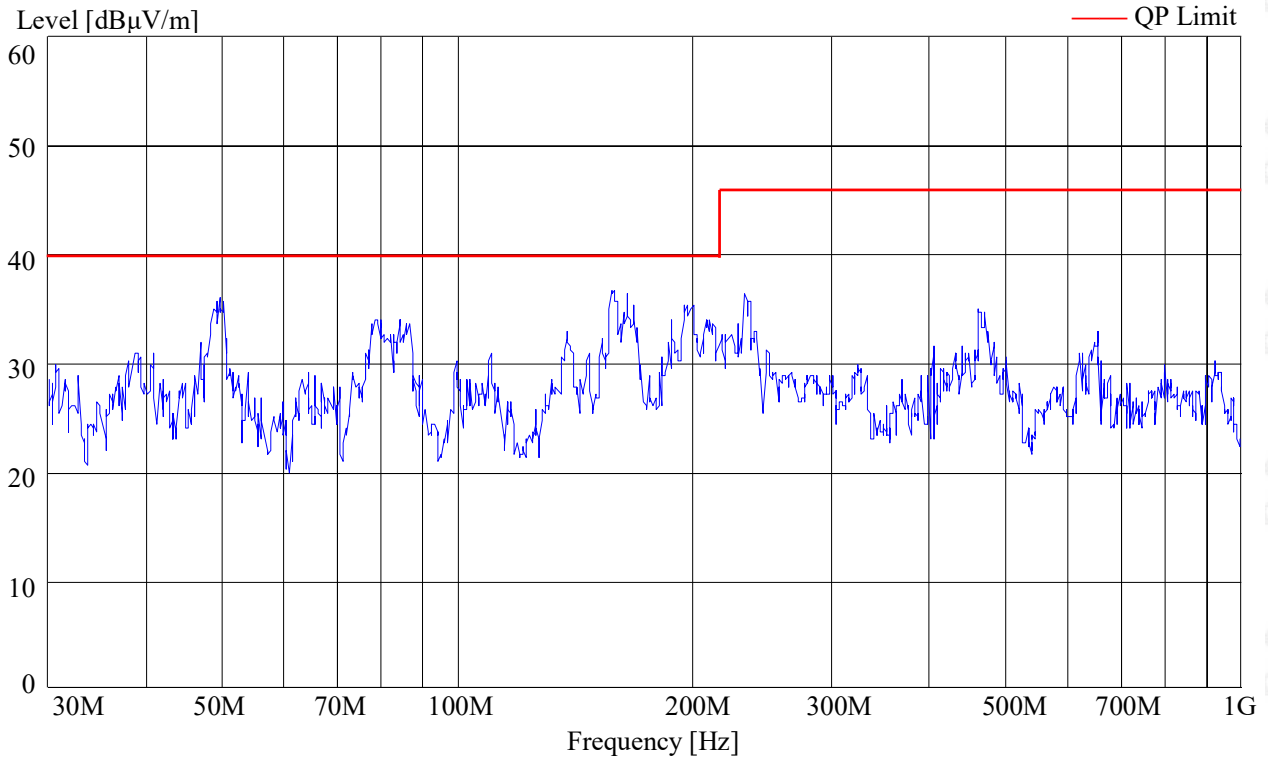

Site: Site 3M

Limit: EN 61000-6-3 Radiation

Temperature: 25°C

EUT: X-ray machine

M/N: SHO-DDX04

Mode: Normal

Note:

Polarization: Vertical

Power: AC 380V

Humidity: 48%

Distance:

No.Mk.	Freq. MHz	Reading Level dBµV/m	Correct Factor dB	Measure- ment dBµV/m	Limit dBµV/m	Over dB	Detector	Antenna Height cm	Table Degree
1	49.666	34.75	0.11	34.86	40.00	-5.14	peak		
2	79.675	32.66	0.13	32.79	40.00	-7.21	peak		
3 *	167.532	35.10	0.15	35.25	40.00	-4.75	peak		
4	170.099	35.02	0.15	35.17	40.00	-4.83	peak		

RESULT: PASS

The results shown in this test report refer only to the sample(s) tested unless otherwise stated and the sample(s) are retained for 30 days only. The document is issued by ENC, this document cannot be reproduced except in full with our prior written permission. The document is available on request and the brief information for its validation can be assessable and confirmed at <http://www.enc-lab.com>.



Radiated Emission Measurement

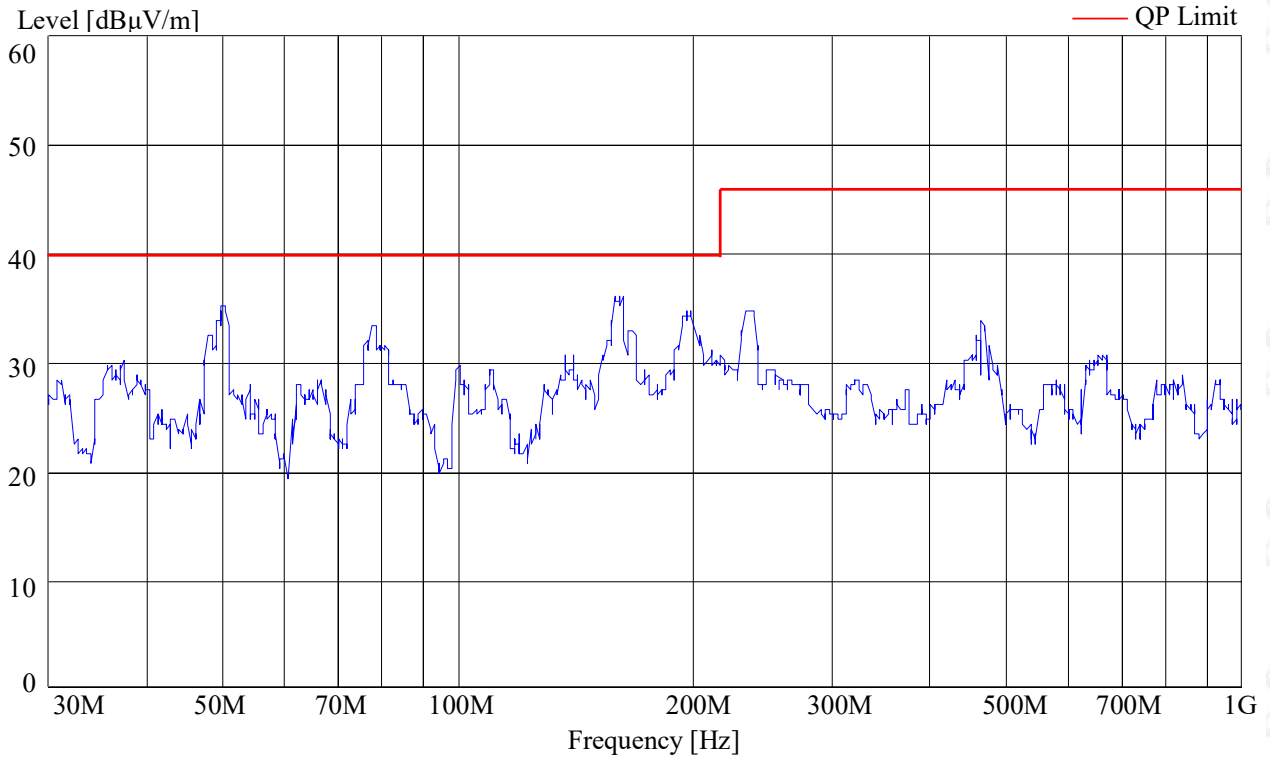

Site: Site 3M

Limit: EN 61000-6-3 Radiation

Temperature: 25°C

EUT: X-ray machine

M/N: SHO-DDX04

Mode: Normal

Note:

Polarization: Horizontal

Power: AC 380V

Humidity: 48%

Distance:

No.Mk.	Freq. MHz	Reading Level dBμV/m	Correct Factor dB	Measurement dBμV/m	Limit dBμV/m	Over dB	Detector	Antenna Height cm	Table Degree
1	49.907	34.17	0.11	34.28	40.00	-5.72	peak		
2	78.178	32.62	0.13	32.75	40.00	-7.25	peak		
3 *	169.626	34.38	0.15	34.53	40.00	-5.47	peak		
4	192.104	33.29	0.15	33.44	40.00	-6.56	peak		

RESULT: PASS

The results shown in this test report refer only to the sample(s) tested unless otherwise stated and the sample(s) are retained for 30 days only. The document is issued by ENC, this document cannot be reproduced except in full with our prior written permission. The document is available on request and the brief information for its validation can be assessable and confirmed at <http://www.enc-lab.com>.



9. IEC 61000-3-12 POWER HARMONICS TEST POWER HARMONICS MEASUREMENT

Port	: AC mains
Basic Standard	: IEC 61000-3-12
Limits	: CLASS A
Tester	: Sam Liu
Temperature	: 25°C
Humidity	: 48%

9.1. TEST EQUIPMENT OF POWER HARMONICS TEST

Description	Manufacturer	Model	Identifier	Last Cal.	Cal. Due
Purified Power	California instruments	HFS500	54513	15/01/2025	14/01/2026
Harmonic And Flicker Analyzer	EM TEST	DPA503S1	1143	15/01/2025	14/01/2026
Software	EM TEST	DPA	1.24.12	N/A	N/A

9.2. BLOCK DIAGRAM OF TEST SETUP

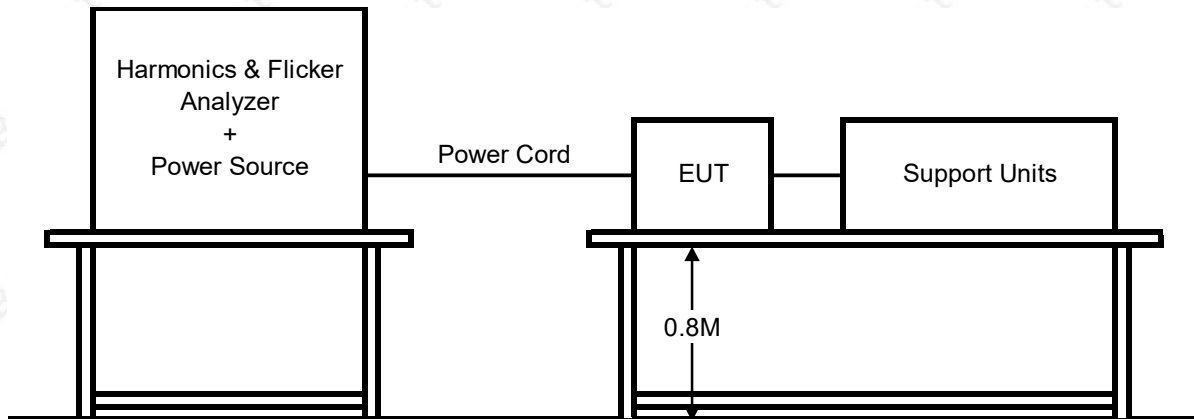

Note:

1. The EUT was tested with the equipment configured to its rated current.
2. The measurements were carried out under steady conditions. When a piece of EUT is brought into operation or is taken out of operation, manually or automatically, harmonic currents and power are not taken into account at first 10s following the switching event. EUT shall not be in standby mode for more than 10% of any observation period.
3. Harmonics of the fundamental current were measured using a digital power meter with an analogue output and frequency analyser which was integrated in the harmonic & flicker test system.
4. For each harmonic order, measure the 1,5 s smoothed r.m.s. harmonic current in each DFT time window and calculate the arithmetic average of the measured values from the DFT time windows, over the entire observation period. Each harmonic order, all 1.5 s smoothed r.m.s. harmonic current values and the average values for the individual harmonic currents, taken over the entire test observation period shall be less than or equal to the applicable limits.

The results shown in this test report refer only to the sample(s) tested unless otherwise stated and the sample(s) are retained for 30 days only. The document is issued by ENC, this document cannot be reproduced except in full with our prior written permission. The document is available on request and the brief information for its validation can be assessable and confirmed at <http://www.enc-lab.com>.

9.3. LIMITS OF HARMONIC CURRENT

Limits	
I_2	4
I_3	21.6
I_4	2
I_5	10.7
I_6	1.3
I_7	7.2
I_8	1
I_9	3.8
I_{10}	0.8
I_{11}	3.1
I_{12}	0.7
I_{13}	2
THD	23
PWHD	23

The results shown in this test report refer only to the sample(s) tested unless otherwise stated and the sample(s) are retained for 30 days only. The document is issued by ENC, this document cannot be reproduced except in full with our prior written permission. The document is available on request and the brief information for its validation can be assessable and confirmed at <http://www.enc-lab.com>.



9.4. RESULT

Test Specification

Test Frequency:	50Hz	Test Voltage:	380Vac
Waveform:	Sine	Test Time:	2.5min
Classification:	Class A	Test result:	PASS

Harmonic current results

Hn	Measured result (A)	Limit[A]	Result
I ₂	0.954	4	PASS
I ₃	13.563	21.6	PASS
I ₄	0.477	2	PASS
I ₅	7.205	10.7	PASS
I ₆	0.318	1.3	PASS
I ₇	4.185	7.2	PASS
I ₈	0.159	1	PASS
I ₉	2.861	3.8	PASS
I ₁₀	0.053	0.8	PASS
I ₁₁	1.960	3.1	PASS
I ₁₂	0.106	0.7	PASS
I ₁₃	1.272	2	PASS
THD	14.411	23	PASS
PWHD	11.762	23	PASS

The results shown in this test report refer only to the sample(s) tested unless otherwise stated and the sample(s) are retained for 30 days only. The document is issued by ENC, this document cannot be reproduced except in full with our prior written permission. The document is available on request and the brief information for its validation can be assessable and confirmed at <http://www.enc-lab.com>.

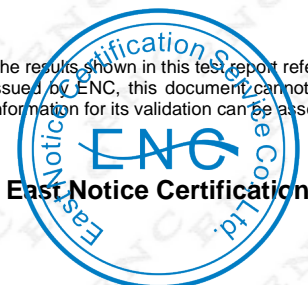

10. IEC 61000-3-11 VOLTAGE FLUCTUATION / FLICKER TEST

VOLTAGE FLUCTUATION/FLICKER MEASUREMENT

Port	: AC mains
Basic Standard	: IEC 61000-3-11
Limits	: §5 of IEC 61000-3-11
Tester	: Sam Liu
Temperature	: 25°C
Humidity	: 48%

10.1. TEST EQUIPMENT OF VOLTAGE FLUCTUATION / FLICKER TEST

Description	Manufacturer	Model	Identifier	Last Cal.	Cal. Due
Purified Power	California instruments	HFS500	54513	15/01/2025	14/01/2026
Harmonic And Flicker Analyzer	EM TEST	DPA503S1	1143	15/01/2025	14/01/2026
Software	EM TEST	DPA	1.24.12	N/A	N/A

10.2. BLOCK DIAGRAM OF TEST SETUP

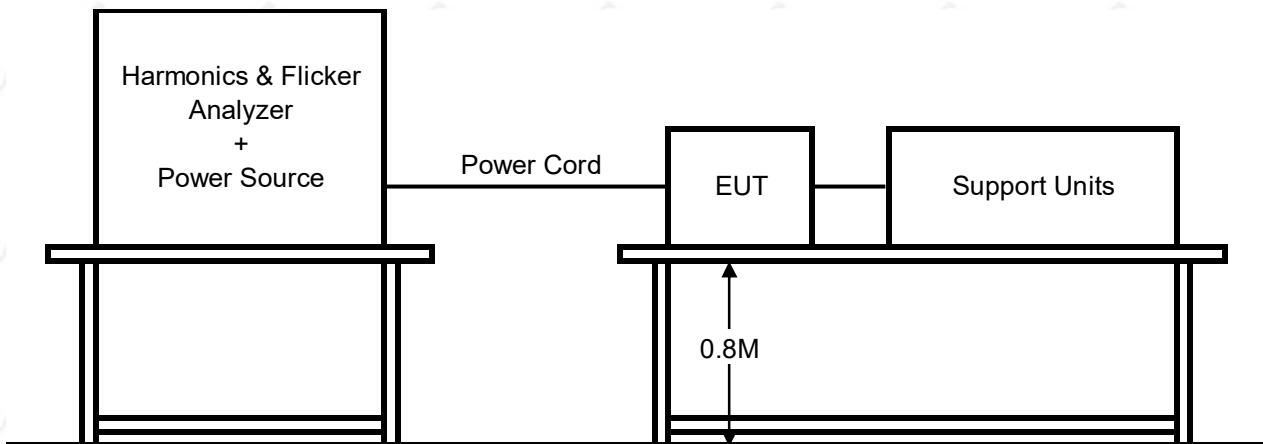

1. The test supply voltage (open-circuit voltage) was the rated voltage of the EUT. The test voltage was maintained within $\pm 2\%$ of the nominal value. The frequency was 50 Hz $\pm 0.5\%$.
2. The voltage fluctuations and flicker were measured at the supply terminals of the EUT.
3. The observation period, T_p , for the assessment of flicker values by flicker measurement, flicker simulation, or analytical method was:
 - for P_{st} , $T_p = 10$ min;
 - for P_{lt} , $T_p = 2$ h.

The observation period included that part of the whole operation cycle in which the EUT produces the most unfavourable sequence of voltage changes.

The results shown in this test report refer only to the sample(s) tested unless otherwise stated and the sample(s) are retained for 30 days only. The document is issued by ENC, this document cannot be reproduced except in full with our prior written permission. The document is available on request and the brief information for its validation can be assessable and confirmed at <http://www.enc-lab.com>.

10.3. RESULT

Flicker Test Summary per EN/IEC61000-3-3 (Run time)

EUT: X-ray machine

Tested by: Sam Liu

Test category: All parameters (European limits)

Test Margin: 100

Test date: 2025-06-09

Test duration (min): 10

Comment: On

Customer: Suzhou Shoimage Medical Equipment Co., Ltd.

Test Result: Pass

Parameter values recorded during the test:

	EUT values		Limit	Result
	$Z_{ref} = Z_{test}$	$Z_{ref} = 25\%Z_{test}$		
Pst	0.87	0.22	1.00	Pass
Plt	0.38	0.09	0.65	Pass
dc [%]	-0.52	-0.13	3.30	Pass
dmax [%]	-5.69	-1.42	6.00	Pass
dt [s]	0.01	0.00	0.50	Pass

Note:

*: The applicant stated the impedance of the supply system (Z_{ref}) for the EUT should be 25% of the test impedance Z_{test} (0.4ohm+j0.3ohm), i.e. the Z_{ref} shall be less than 0.1ohm+j0.075ohm

More details about the Zref please refer the EN 61000-3-11 clause 6.1.3 listed as below:

6.1.3 Evaluation against Z_{ref}

If Z_{test} is not equal to Z_{ref} , the measured values shall be recalculated using the following formulae:

$$d_c = d_{c\ test} \cdot \frac{Z_{ref}}{Z_{test}}$$

$$d_{max} = d_{max\ test} \cdot \frac{Z_{ref}}{Z_{test}}$$

$$P_{st} = P_{st\ test} \cdot \frac{Z_{ref}}{Z_{test}}$$

$$P_{lt} = P_{lt\ test} \cdot \frac{Z_{ref}}{Z_{test}}$$

The values d_c , d_{max} , P_{st} , P_{lt} are similar to those which would be obtained by measurements using Z_{ref} as the conditions placed on Z_{test} in 6.1.1 ensure that the modulus values of Z_{test} and Z_{ref} are approximately "in phase" and that the measured voltage, P_{st} and P_{lt} values can be converted to equivalent values with reasonable accuracy by multiplying them by the ratio $\frac{Z_{ref}}{Z_{test}}$.

Provided that the conditions for d_c and d_{max} are met with Z_{test} , $d(t)$ shall be deemed to be satisfied.

The results shown in this test report refer only to the sample(s) tested unless otherwise stated and the sample(s) are retained for 30 days only. The document is issued by ENC, this document cannot be reproduced except in full with our prior written permission. The document is available on request and the brief information for its validation can be assessable and confirmed at <http://www.enc-lab.com>.

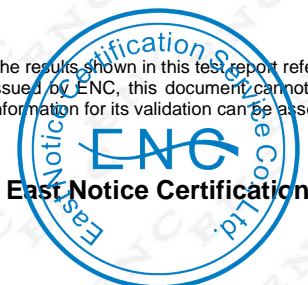

11. IEC 61000-4-2 ESD IMMUNITY TEST ELECTROSTATIC DISCHARGE (ESD) IMMUNITY TEST

Port	: Enclosure
Basic Standard	: IEC 61000-4-2:2008
Test Level	: ±8 kV (Air Discharge) ±4 kV (Contact Discharge) ±4 kV (Indirect Discharge)
Standard require	: B
Tester	: Sam Liu
Temperature	: 25°C
Humidity	: 48%

11.1. TEST EQUIPMENT OF ESD TEST

Description	Manufacturer	Model	Identifier	Last Cal.	Cal. Due
ESD Simulator	EM-Test	EST883	N/A	15/01/2025	14/01/2026

11.2. BLOCK DIAGRAM OF TEST SETUP

(The 470 k ohm resistors are installed per standard requirement)

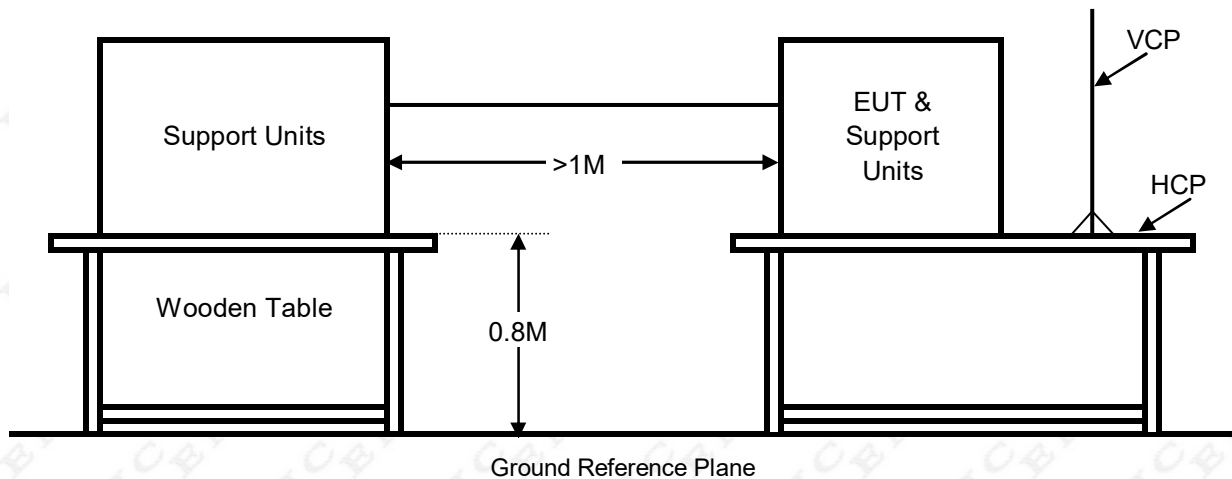

10.3. TEST PROCEDURE

The EUT was located 0.1 m minimum from all side of the HCP.

The support units were located 1 m minimum away from the EUT.

EUT worked with resistance load, and make sure EUT worked normally.

Actives the communication function if the EUT with such port(s).

As per the requirement of EN 61000-6-1: Contact discharge is the preferred test method. 20 discharges (10 with positive and 10 negative polarity) shall be applied on each accessible metal part of the enclosure. In case of a non-conductive enclosure, discharges shall be applied on the horizontal or vertical coupling planes as specified in IEC 61000-4-2.

Air discharges shall be used where contact discharges cannot be applied.

The results shown in this test report refer only to the sample(s) tested unless otherwise stated and the sample(s) are retained for 30 days only. The document is issued by ENC, this document cannot be reproduced except in full with our prior written permission. The document is available on request and the brief information for its validation can be assessable and confirmed at <http://www.enc-lab.com>.

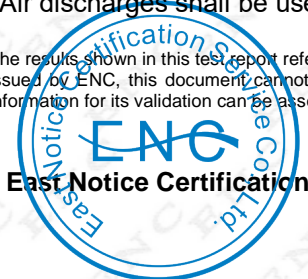

The following test condition was followed during the tests.

Note: As per the A2 to IEC 61000-4-2, a bleed resistor cable is connected between the EUT and HCP during the test.

The electrostatic discharges were applied as follows:

Amount of Discharges	Voltage	Coupling	Result (Pass/Fail)
Mini 20 /Point	±2kV; ±4kV	Contact Discharge	Pass
Mini 10 /Point	±2kV; ±4kV	Indirect Discharge HCP (Front)	Pass
Mini 10 /Point	±2kV; ±4kV	Indirect Discharge VCP (Left)	Pass
Mini 10 /Point	±2kV; ±4kV	Indirect Discharge VCP (Back)	Pass
Mini 10 /Point	±2kV; ±4kV	Indirect Discharge VCP (Right)	Pass
Mini 10 /Point	±2kV; ±4kV;±8kV;	Air Discharge	Pass

11.4. PERFORMANCE & RESULT

- Criteria A: The apparatus continues to operate as intended. No degradation of performance or loss of function is allowed below a performance level specified by the manufacturer, when the apparatus is used as intended. In some cases the performance level may be replaced by a permissible loss of performance.
- Criteria B: The apparatus continues to operate as intended after the test. No degradation of performance or loss of function is allowed below a performance level specified by the manufacturer, when the apparatus is used as intended. In some cases the performance level may be replaced by a permissible loss of performance. During the test, degradation of performance is however allowed.
- Criteria C: Temporary loss of function is allowed, provided the functions self recoverable or can be restored by the operation of controls.

PASS **FAIL**

The results shown in this test report refer only to the sample(s) tested unless otherwise stated and the sample(s) are retained for 30 days only. The document is issued by ENC, this document cannot be reproduced except in full with our prior written permission. The document is available on request and the brief information for its validation can be assessable and confirmed at <http://www.enc-lab.com>.

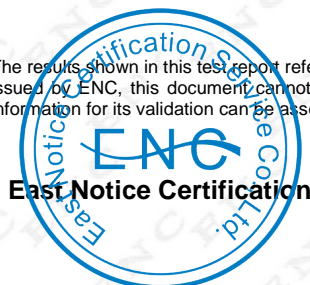

12. IEC 61000-4-3 TEST RADIATED ELECTROMAGNETIC FIELD IMMUNITY TEST

Port	: Enclosure
Basic Standard	: IEC 61000-4-3:2020
Test Level	: 3V/m with 80% AM. 1kHz Modulation.
Standard require	: A
Tester	: Sam Liu
Temperature	: 25°C
Humidity	: 48%

12.1. TEST EQUIPMENT

Description	Manufacturer	Model	Identifier	Last Cal.	Cal. Due
Signal generator	Agilent	N5181A	4906012	15/01/2025	14/01/2026
Power Amplifier	MicoTop	MPA-80	751000	15/01/2025	14/01/2026
Power Meter	Agilent	E4419B	4331787	15/01/2025	14/01/2026
Test Antenna- Bi-Log	Schwarzbeck	VULB 9118 E	4911	15/01/2025	14/01/2026
Horn Antenna	Sunol Sciences	DRH-118	A062013	15/01/2025	14/01/2026
Power transmitter	HP	8481A	2349A	15/01/2025	14/01/2026

12.2. BLOCK DIAGRAM OF TEST SETUP

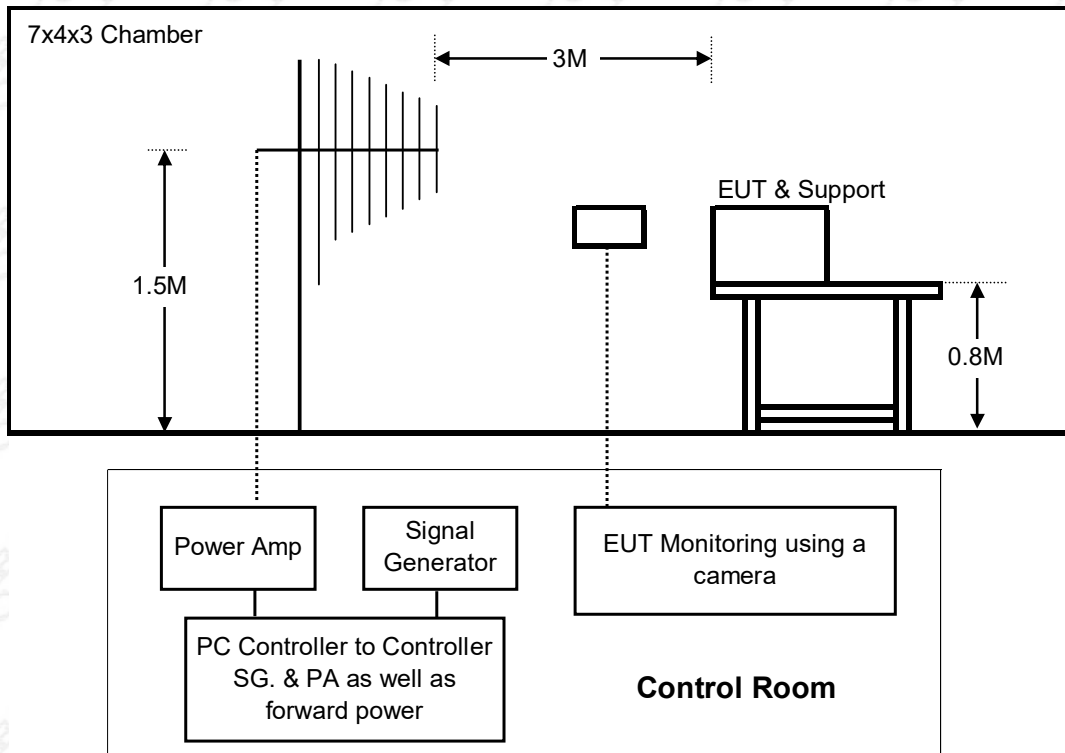

The results shown in this test report refer only to the sample(s) tested unless otherwise stated and the sample(s) are retained for 30 days only. The document is issued by ENC, this document cannot be reproduced except in full with our prior written permission. The document is available on request and the brief information for its validation can be assessable and confirmed at <http://www.enc-lab.com>.

12.3. TEST PROCEDURE

The EUT was located at the edge of supporting table keep 3 meter away from transmitting antenna, it just the calibrated square area of field uniformity. The support units were located outside of the uniformity area, but the cable(s) connected with EUT were exposed to the calibrated field as per IEC 61000-4-3.

EUT worked with resistance load, and make sure EUT worked normally.

Setting the testing parameters of RS test software per IEC 61000-4-3.

Performing the test at each side of with specified level (30V/m) at 1% steps and test frequency from 80MHz to 1000MHz and 1400MHz to 2700MHz.

Recording the test result in following table.

It is not necessary to perform test as per annex A of EN 61000-6-1 if the EUT doesn't belong to TTE product.

IEC 61000-4-3 Final test conditions:

Test level : 3V/m
Steps : 1 % of fundamental
Dwell Time : 1 sec

Range (MHz)	Field	Modulation	Polarity	Position	Result (Pass/Fail)
80-1000 / 1400-2700	3V/m	AM	H	Front	Pass
80-1000 / 1400-2700	3V/m	AM	H	Left	Pass
80-1000 / 1400-2700	3V/m	AM	H	Back	Pass
80-1000 / 1400-2700	3V/m	AM	H	Right	Pass
80-1000 / 1400-2700	3V/m	AM	V	Front	Pass
80-1000 / 1400-2700	3V/m	AM	V	Left	Pass
80-1000 / 1400-2700	3V/m	AM	V	Back	Pass
80-1000 / 1400-2700	3V/m	AM	V	Right	Pass

12.4. PERFORMANCE & RESULT

- Criteria A: The apparatus continues to operate as intended. No degradation of performance or loss of function is allowed below a performance level specified by the manufacturer, when the apparatus is used as intended. In some cases the performance level may be replaced by a permissible loss of performance.
- Criteria B: The apparatus continues to operate as intended after the test. No degradation of performance or loss of function is allowed below a performance level specified by the manufacturer, when the apparatus is used as intended. In some cases the performance level may be replaced by a permissible loss of performance. During the test, degradation of performance is however allowed.
- Criteria C: Temporary loss of function is allowed, provided the functions self recoverable or can be restored by the operation of controls.

PASS **FAIL**

The results shown in this test report refer only to the sample(s) tested unless otherwise stated and the sample(s) are retained for 30 days only. The document is issued by ENC, this document cannot be reproduced except in full with our prior written permission. The document is available on request and the brief information for its validation can be assessable and confirmed at <http://www.enc-lab.com>.



13. IEC 61000-4-4 TEST ELECTRICAL FAST TRANSIENTS/BURST IMMUNITY TEST

Port : On Power Supply Lines
Basic Standard : IEC 61000-4-4:2012
Test Level : +/- 1kV for Power Supply Lines
Standard require : B
Tester : Sam Liu
Temperature : 25°C
Humidity : 48%

13.1. TEST EQUIPMENT

Description	Manufacturer	Model	Identifier	Last Cal.	Cal. Due
Ultra Compact Simulator	EM-Test	UCS500M	0500-19	15/01/2025	14/01/2026
3-Phase Coupling Network	EM-Test	CNI503 S5/16A	0606-01	15/01/2025	14/01/2026
Test Software	EM-Test	ISM IEC	V1.2.6	N/A	N/A

13.2. BLOCK DIAGRAM OF TEST SETUP

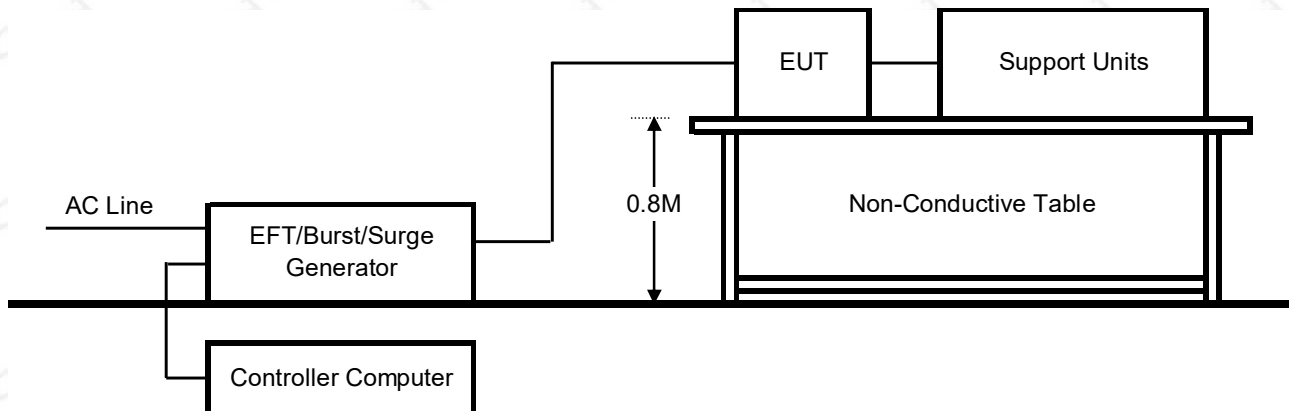

The results shown in this test report refer only to the sample(s) tested unless otherwise stated and the sample(s) are retained for 30 days only. The document is issued by ENC, this document cannot be reproduced except in full with our prior written permission. The document is available on request and the brief information for its validation can be assessable and confirmed at <http://www.enc-lab.com>.

13.3. TEST PROCEDURE

The EUT and support units were located on a wooden table 0.8m away from ground reference plane.

A 1.0 meter long power cord was attached to EUT during the test.

The length of communication cable between communication port and clamp was keeping within 1 meter.

EUT worked with resistance load, and make sure EUT worked normally.

Related peripherals work during the test.

Recording the test result as shown in following table.

Test conditions:

Impulse Frequency: 5 kHz

Tr/Th: 5/50ns

Burst Duration: 15ms

Burst Period: 300ms

Inject Line	Voltage kV	Inject Method	Result (Pass/Fail)
L	+ /- 1	Direct	Pass
N	+ /- 1	Direct	Pass
PE	+ /- 1	Direct	Pass
L+N	+ /- 1	Direct	Pass
L+PE	+ /- 1	Direct	Pass
N+PE	+ /- 1	Direct	Pass
L+N+PE	+ /- 1	Direct	Pass

13.4. PERFORMANCE & RESULT

Criteria A: The apparatus continues to operate as intended. No degradation of performance or loss of function is allowed below a performance level specified by the manufacturer, when the apparatus is used as intended. In some cases the performance level may be replaced by a permissible loss of performance.

Criteria B: The apparatus continues to operate as intended after the test. No degradation of performance or loss of function is allowed below a performance level specified by the manufacturer, when the apparatus is used as intended. In some cases the performance level may be replaced by a permissible loss of performance. During the test, degradation of performance is however allowed.

Criteria C: Temporary loss of function is allowed, provided the functions self recoverable or can be restored by the operation of controls.

PASS

FAIL

The results shown in this test report refer only to the sample(s) tested unless otherwise stated and the sample(s) are retained for 30 days only. The document is issued by ENC, this document cannot be reproduced except in full with our prior written permission. The document is available on request and the brief information for its validation can be assessable and confirmed at <http://www.enc-lab.com>.

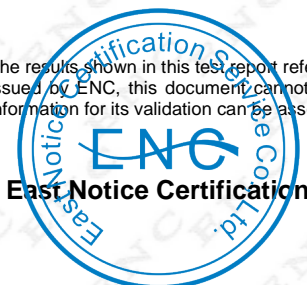

14. IEC 61000-4-5 SURGE IMMUNITY TEST

SURGE IMMUNITY TEST

Port	: On Power Supply Lines
Basic Standard	: IEC 61000-4-5:2017
Requirements	: +/- 1kV (Line to Line) +/- 2kV (Line to Ground)
Standard require	: B
Tester	: Sam Liu
Temperature	: 25°C
Humidity	: 48%

14.1. TEST EQUIPMENT OF SURGE TEST

Description	Manufacturer	Model	Identifier	Last Cal.	Cal. Due
Ultra Compact Simulator	EM-Test	UCS500M	0500-19	15/01/2025	14/01/2026
3-Phase Coupling Network	EM-Test	CNI503 S5/16A	0606-01	15/01/2025	14/01/2026
Test Software	EM-Test	ISM IEC	V1.1.2	N/A	N/A

14.2. BLOCK DIAGRAM OF TEST SETUP

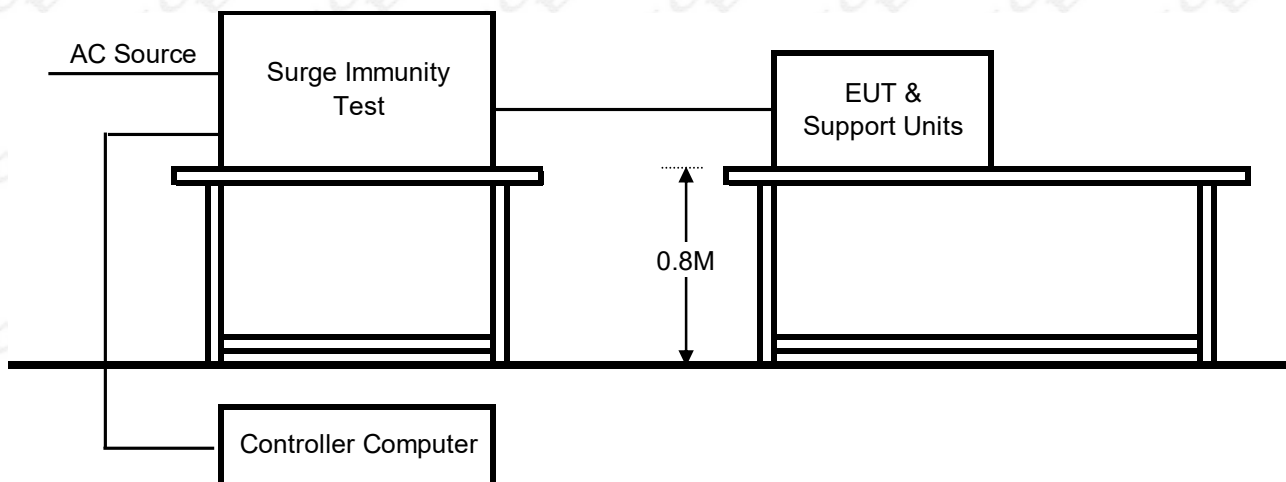

The results shown in this test report refer only to the sample(s) tested unless otherwise stated and the sample(s) are retained for 30 days only. The document is issued by ENC, this document cannot be reproduced except in full with our prior written permission. The document is available on request and the brief information for its validation can be assessable and confirmed at <http://www.enc-lab.com>.

14.3. TEST PROCEDURE

The EUT and support units were located on a wooden table 0.8 m away from ground floor.

EUT worked with resistance load, and make sure EUT worked normally.

Recording the test result as shown in following table.

Test conditions:

Voltage Waveform	:	1.2/50 us
Current Waveform	:	8/20 us
Polarity	:	Positive/Negative
Phase angle	:	0°, 90°, 270°
Number of Test	:	5

Coupling Line	Voltage (kV)	Polarity	Coupling Method	Result (Pass/Fail)
L-N	1	Positive	Capacitive	Pass
L-N	1	Negative	Capacitive	Pass
L-PE	2	Positive	Capacitive	Pass
L-PE	2	Negative	Capacitive	Pass
N-PE	2	Positive	Capacitive	Pass
N-PE	2	Negative	Capacitive	Pass

14.4. PERFORMANCE & RESULT

Criteria A: The apparatus continues to operate as intended. No degradation of performance or loss of function is allowed below a performance level specified by the manufacturer, when the apparatus is used as intended. In some cases the performance level may be replaced by a permissible loss of performance.

Criteria B: The apparatus continues to operate as intended after the test. No degradation of performance or loss of function is allowed below a performance level specified by the manufacturer, when the apparatus is used as intended. In some cases the performance level may be replaced by a permissible loss of performance. During the test, degradation of performance is however allowed.

Criteria C: Temporary loss of function is allowed, provided the functions self recoverable or can be restored by the operation of controls.

PASS **FAIL**

The results shown in this test report refer only to the sample(s) tested unless otherwise stated and the sample(s) are retained for 30 days only. The document is issued by ENC, this document cannot be reproduced except in full with our prior written permission. The document is available on request and the brief information for its validation can be assessable and confirmed at <http://www.enc-lab.com>.

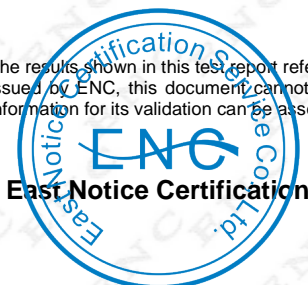

15. IEC 61000-4-6 TEST

IEC 61000-4-6 IMMUNITY TO CONDUCTED DISTURBANCES, INDUCED BY RADIO-FREQUENCY FIELD

Port	:	Power Supply Lines
Basic Standard	:	IEC 61000-4-6:2008
Requirements	:	3V with 80% AM. 1 kHz Modulation
Standard require	:	A
Tester	:	Sam Liu
Temperature	:	25°C
Humidity	:	48%

15.1. TEST EQUIPMENT

Description	Manufacturer	Model	Identifier	Last Cal.	Cal. Due
Ultra Compact Simulator	EM TEST	UCS500M6	202304/060	15/01/2025	14/01/2026
Motor Driven Voltage Transformer	EM TEST	MV2616	302205	15/01/2025	14/01/2026
Current Transformer	EM TEST	MC2630	302389	15/01/2025	14/01/2026
Magnetic Coil	EM TEST	MS100	0010230A	15/01/2025	14/01/2026
Test Software	EM TEST	ISM IEC	V1.1.7	N/A	N/A

15.2. BLOCK DIAGRAM OF TEST SETUP

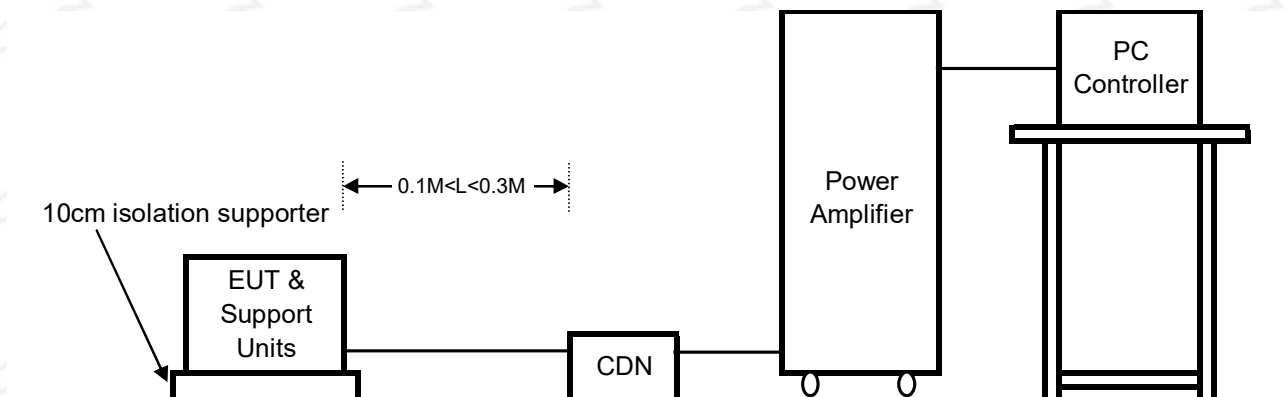

The results shown in this test report refer only to the sample(s) tested unless otherwise stated and the sample(s) are retained for 30 days only. The document is issued by ENC, this document cannot be reproduced except in full with our prior written permission. The document is available on request and the brief information for its validation can be assessable and confirmed at <http://www.enc-lab.com>.

15.3. TEST PROCEDURE

The EUT and support units were located at a ground reference plane with the interposition of a 0.1 m thickness insulating support and the CDN was located on GRP directly.

EUT worked with resistance load, and make sure EUT worked normally.

Related peripherals work during the test.

Setting the testing parameters of CS test software per IEC 61000-4-6.

Recording the test result in following table.

Test conditions:

Frequency Range: 0.15MHz-230MHz

Frequency Step: 1% of fundamental

Dwell Time: 1 sec

Range (MHz)	Strength	Modulation	Result (Pass/Fail)
0.15-230	3V	AM	Pass

15.4. PERFORMANCE & RESULT

Criteria A: The apparatus continues to operate as intended. No degradation of performance or loss of function is allowed below a performance level specified by the manufacturer, when the apparatus is used as intended. In some cases the performance level may be replaced by a permissible loss of performance.

Criteria B: The apparatus continues to operate as intended after the test. No degradation of performance or loss of function is allowed below a performance level specified by the manufacturer, when the apparatus is used as intended. In some cases the performance level may be replaced by a permissible loss of performance. During the test, degradation of performance is however allowed.

Criteria C: Temporary loss of function is allowed, provided the functions self recoverable or can be restored by the operation of controls.

PASS

FAIL

The results shown in this test report refer only to the sample(s) tested unless otherwise stated and the sample(s) are retained for 30 days only. The document is issued by ENC, this document cannot be reproduced except in full with our prior written permission. The document is available on request and the brief information for its validation can be assessable and confirmed at <http://www.enc-lab.com>.

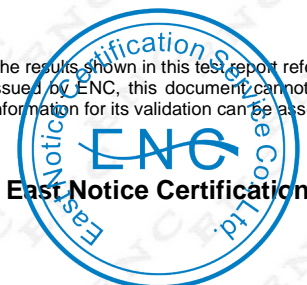

16. IEC 61000-4-11 TEST

VOLTAGE DIPS, SHORT INTERRUPTIONS AND VOLTAGE VARIATIONS IMMUNITY TEST

Port	: Power Supply Lines
Basic Standard	: IEC 61000-4-11:2020
Requirements	: 0, 45, 90, 135, 180, 225, 270, 315 degrees
Standard require	: Min. 10 sec.
Test Interval:	: Sam Liu
Temperature	: 25°C
Humidity	: 48%

Voltage Dips	Test Level	Reduction	Duration	Performance
	% U_T	(%)	(periods)	Criteria
	40	60	10	C
	70	30	25	C

Voltage Interruptions	Test Level	Reduction	Duration	Performance
	% U_T	(%)	(periods)	Criteria
	0	100	0.5	C

16.1. TEST EQUIPMENT

Description	Manufacturer	Model	Identifier	Last Cal.	Cal. Due
Purified Power Source	CALIFORNIA INSTRUMENTS	HFS500	54513	15/01/2025	14/01/2026
Test Software	EM TEST	CNV504S1	N/A	15/01/2025	14/01/2026

16.2. BLOCK DIAGRAM OF TEST SETUP

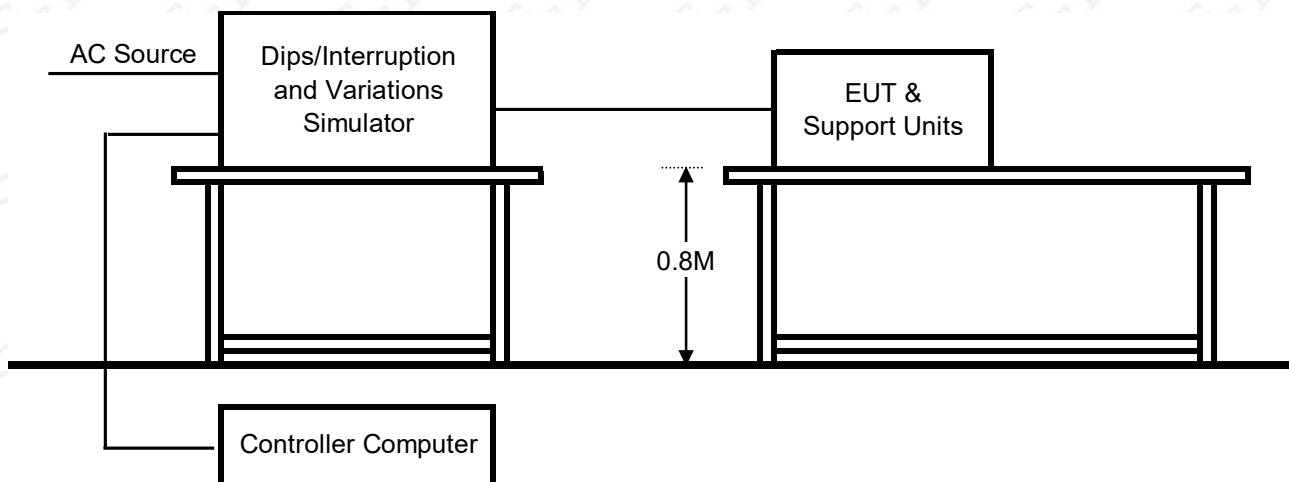

The results shown in this test report refer only to the sample(s) tested unless otherwise stated and the sample(s) are retained for 30 days only. The document is issued by ENC, this document cannot be reproduced except in full with our prior written permission. The document is available on request and the brief information for its validation can be assessable and confirmed at <http://www.enc-lab.com>.

16.3. TEST PROCEDURE

The EUT and support units were located on a wooden table, 0.8 m away from ground floor. EUT worked with resistance load, and make sure EUT worked normally.

Setting the parameter of tests and then perform the test software of test simulator.

Conditions changes to occur at 0 degree crossover point of the voltage waveform.

Recording the test result in test record form.

Test conditions:

The duration with a sequence of three dips/interruptions with interval of 10 s minimum
(Between each test event)

Voltage Dips and Interruptions:

Test Level % U_T	Reduction (%)	Duration (periods)	Observation	Meet Performance Criteria
0	100	0.5	Normal	B
70	30	10	Normal	C

16.4. PERFORMANCE

- Criteria A: The apparatus continues to operate as intended. No degradation of performance or loss of function is allowed below a performance level specified by the manufacturer, when the apparatus is used as intended. In some cases the performance level may be replaced by a permissible loss of performance.
- Criteria B: The apparatus continues to operate as intended after the test. No degradation of performance or loss of function is allowed below a performance level specified by the manufacturer, when the apparatus is used as intended. In some cases the performance level may be replaced by a permissible loss of performance. During the test, degradation of performance is however allowed.
- Criteria C: Temporary loss of function is allowed, provided the functions self recoverable or can be restored by the operation of controls.

 PASS **FAIL**

The results shown in this test report refer only to the sample(s) tested unless otherwise stated and the sample(s) are retained for 30 days only. The document is issued by ENC, this document cannot be reproduced except in full with our prior written permission. The document is available on request and the brief information for its validation can be assessable and confirmed at <http://www.enc-lab.com>.

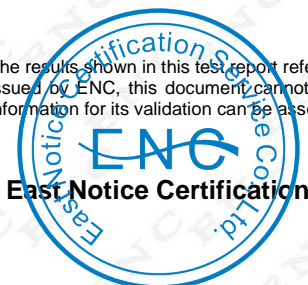

APPENDIX 1 PHOTOGRAPH(S) OF EUT

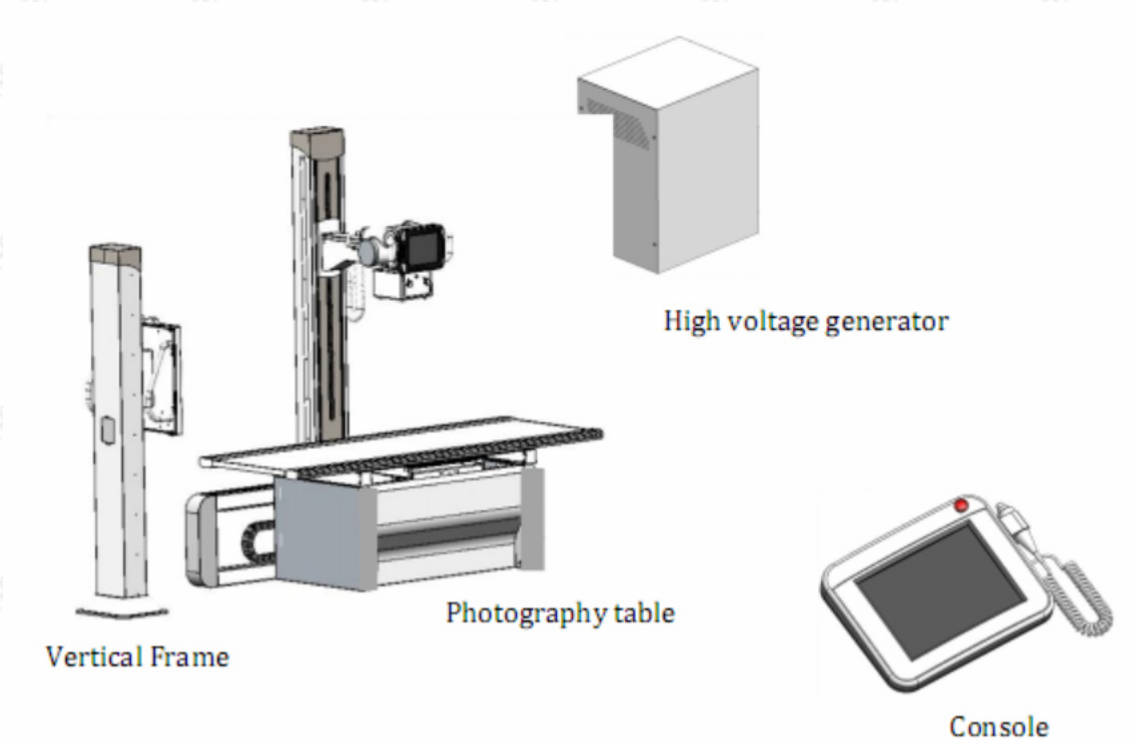

----END OF REPORT----

The results shown in this test report refer only to the sample(s) tested unless otherwise stated and the sample(s) are retained for 30 days only. The document is issued by ENC, this document cannot be reproduced except in full with our prior written permission. The document is available on request and the brief information for its validation can be assessable and confirmed at <http://www.enc-lab.com>.